



 Pinze per movimentazione tronchi e materiali vari  
 Grabs for logs' and different materials' handling  
 Pincés pour la manipulation des troncs et des matériaux divers

 Holzgreifer und verschiedenen Materialumschlag  
 Pinzas para troncos y materiales diversos  
 Грейфер для круглого леса и других материалов

&gt; R50



R103A



R104A

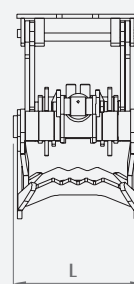
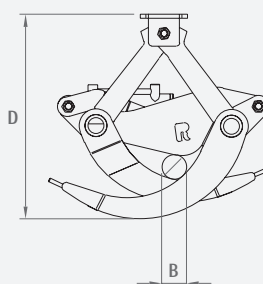
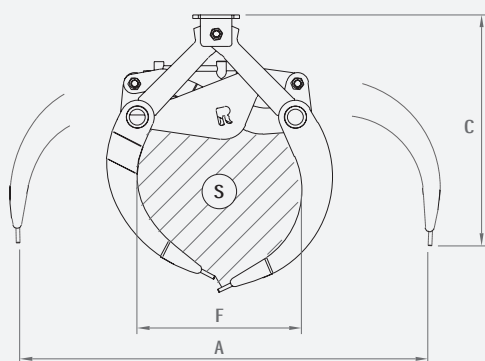

Modello	Area	Portata	Peso	Pressione	Portata olio	Dimensioni					
Model	Surface	Lifting capacity	Weight	Pressure	Oil flow	Sizes					
Modèle	Surface	Portée	Poids	Pression	Débit d'huile	Dimensions					
Modell	Oberfläche	Tragkraft	Gewicht	Druck	Ölleistung	Abmessungen					
	S - m <sup>2</sup>	Kg	kg	bar	l/min	A	B	C	D	L	F
R50/250	0,2	800	120	180	40	1310	60	790	680	390	530
R50/350	0,3	1200	195	180	70	1450	80	880	760	500	650
R50/500	0,5	1500	220	180	70	1750	250	950	940	510	880